



# SP6003

## Synchronous Rectifier Driver

### DESCRIPTION

The fundamental of SP6003 synchronous rectifier (SR) driver IC is based on our U.S. patented methods that utilize the principle of “prediction” logic circuit. The IC deliberates previous cycle timing to control the SR in present cycle by “predictive” algorithm that makes adjustments to the turn-off time, in order to achieve maximum efficiency and avoid cross-conduction at the same time. It also maintains the MOSFET’s body diode conduction at minimum level. The SP6003 is capable to adapt in almost all existing flyback converters with few adjustments considered necessary.

### FEATURES

- Offers efficiency improvement over Schottky Diode (depends on drive configuration of the SR).
- Drives all logic level Power MOSFET.
- Prediction gate timing control.
- Minimum MOSFET body diode conduction.
- Operating frequency up to 350 KHz.
- Synchronize to transformer secondary voltage waveform.

### APPLICATIONS

- Servers & workstations
- Storage area network power supplies
- Telecommunication converters
- Embedded systems
- Industrial & commercial systems using high current processors

### PIN CONFIGURATION (SOP-8)

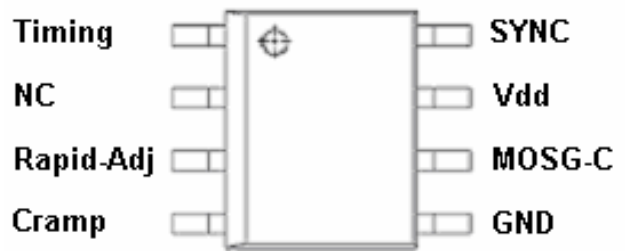

### PART MARKING

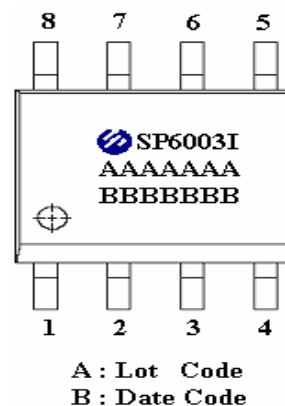



# SP6003 Synchronous Rectifier Driver

## TYPICAL APPLICATION CIRCUIT

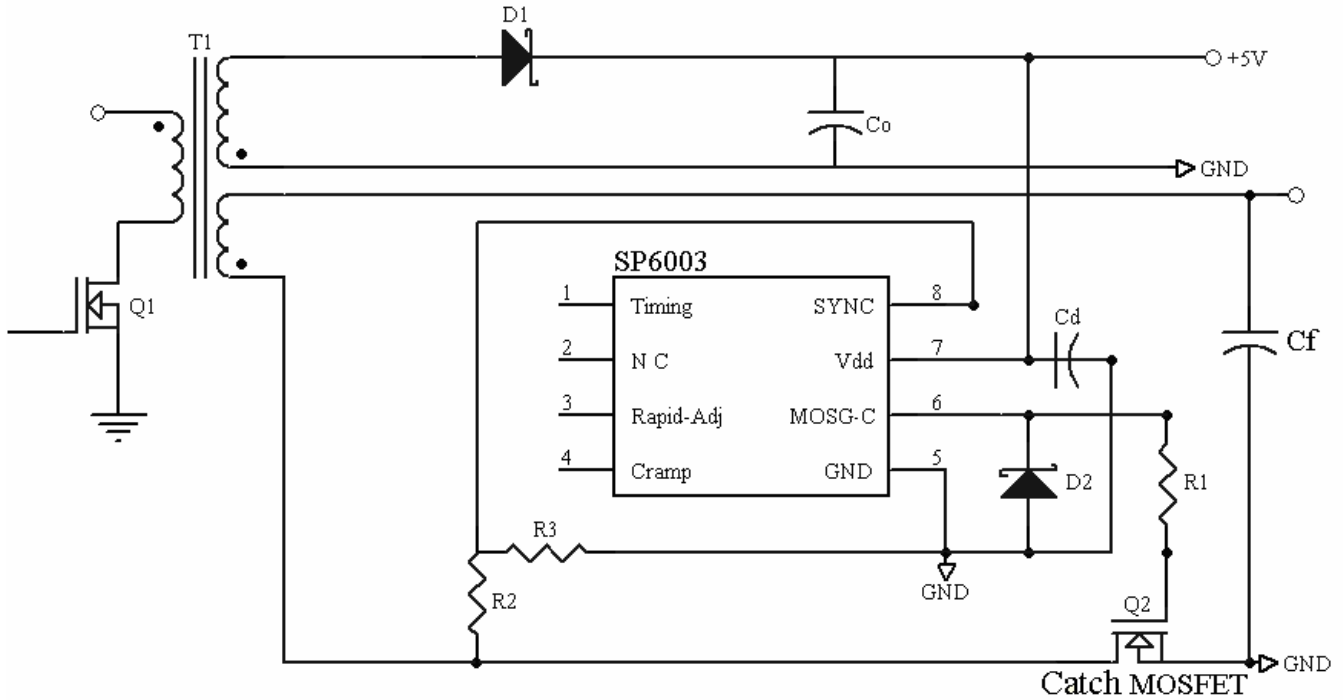

## PIN DESCRIPTION

Pin	Symbol	Description
1	Timing	Discontinuous current filter timing adjustment resistor connection.
2	NC	No connection.
3	Rapid-Adj	Capacitor connection to adjust fast pulse width reduction response.
4	Cramp	Ramp capacitor adjustment to extend MOSFET's gate timing.
5	GND	Ground connection.
6	MOSG-C	Catch MOSFET gate drive.
7	Vdd	DC supply voltage.
8	SYNC	Synchronized signal from transformer's output.



# SP6003

## Synchronous Rectifier Driver

### BLOCK DIAGRAM

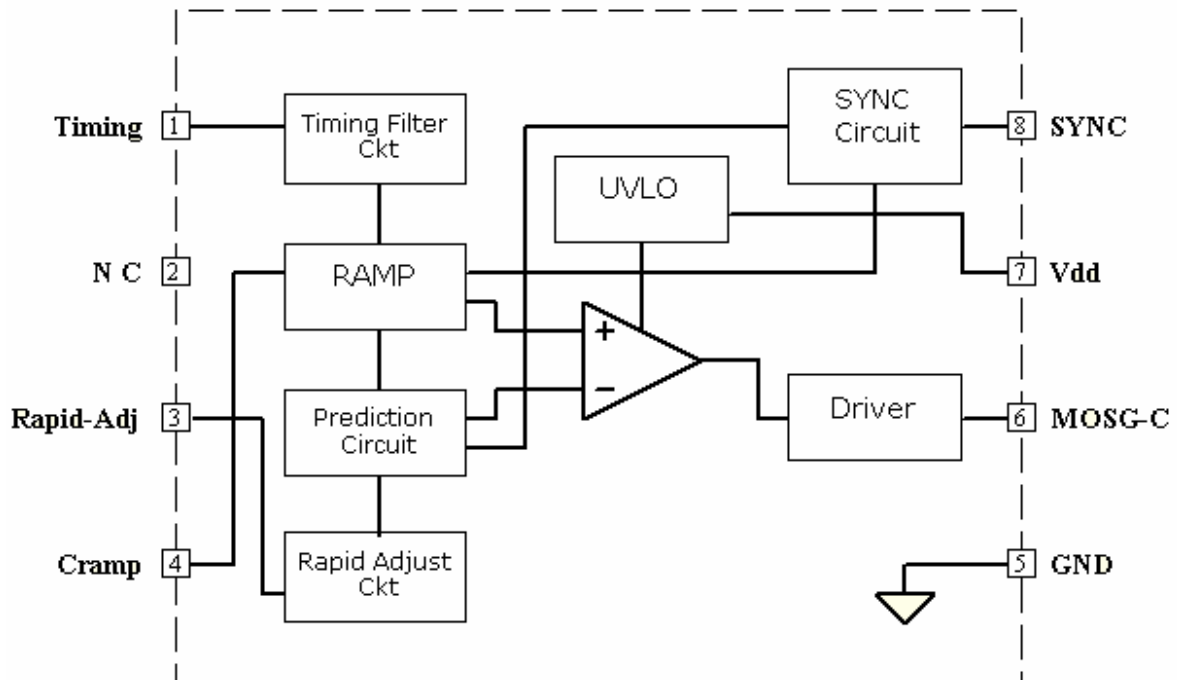

### ORDERING INFORMATION

Part Number	Package	Part Marking
SP6003S8RG	SOP-8	SP6003I
SP6003S8TG	SOP-8	SP6003I

※ SP6003S8RG : 7" Tape Reel ; Pb – Free

※ SP6003S8TG : Tube ; Pb – Free

### ABSOLUTE MAXIMUM RATINGS (TA=25°C, unless otherwise specified.)

The following ratings designate persistent limits beyond which damage to the device may occur.

Symbol	Parameter	Value	Unit
V <sub>dd</sub>	DC Supply Voltage	7	V
SYNC	SYNC Voltage	7.5	V
I <sub>OUT</sub>	Peak Source Current (Pulsed)	1	A
	Peak Sink Current (Pulsed)	1.5	A
P <sub>D</sub>	Power Dissipation (@ T <sub>A</sub> =85°C (*))	0.25	W
T <sub>J</sub>	Operating Junction Temperature Range	-40 to 150	°C
T <sub>STG</sub>	Storage Temperature Range	-40 to 150	°C
T <sub>LEAD</sub>	Lead Soldering Temperature for 5 sec.	260	°C



# SP6003

## Synchronous Rectifier Driver

### THERMAL RESISTANCE

Symbol	Parameter	Value	Unit
$R_{\theta JC}$	Thermal Resistance Junction – Case (*)	45	$^{\circ}C/W$

(\*) The power dissipation and thermal resistance are evaluated under copper board mounted with free air conditions.

### ELECTRICAL CHARACTERISTICS

( $T_A=25^{\circ}C$ ,  $V_{dd}=5V$ ,  $V_{SYNC}=5V$ , Freq. =300 KHz, Duty Cycle=50%, unless otherwise specified.)

Symbol	Parameter	Conditions	Min.	Typ.	Max.	Unit
<b>SUPPLY INPUT</b>						
$I_{DD}$	Supply current	No load	4	5.5	8	mA
$V_{onth}$	Vdd turn on threshold			5.0	7.0	V
$V_{offth}$	Vdd turn off threshold		3.8	4.1		V
<b>SYNC REFERENCE (SYNC)</b>						
$V_{shth}$	SYNC high threshold		3.9	5.0		V
$V_{slth}$	SYNC low threshold			0.9	1.2	V
<b>MOSFET GATE DRIVER (MOSG-C)</b>						
$V_{oh}$	Output high voltage	$I_o = -200mA$	4.8	4.9	5.0	V
$V_{ol}$	Output low voltage	$I_o = 200mA$	0.0	0.1	0.2	V
$T_d$	Propagation delay	No load	15	20	25	ns
$T_r$	Rise time	Load = 1nF (*)	24	28	36	ns
$T_f$	Fall time	Load = 1nF (*)	20	23	30	ns

(\*)  $T_r$  &  $T_f$  are measured among 10% and 90% of starting and final voltage.

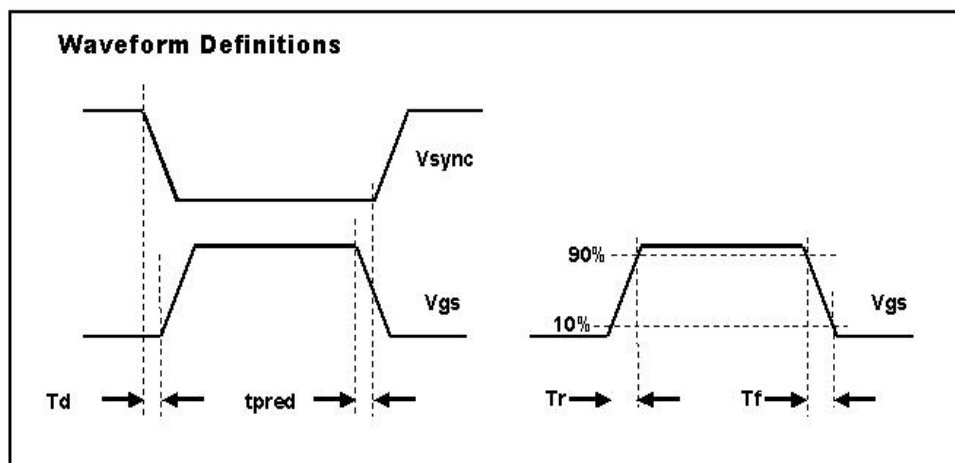



# SP6003 Synchronous Rectifier Driver

## PERFORMANCE CHARACTERISTICS ( $T_A=25^\circ\text{C}$ , unless otherwise specified.)

Figure 1: Supply Current vs Supply Voltage

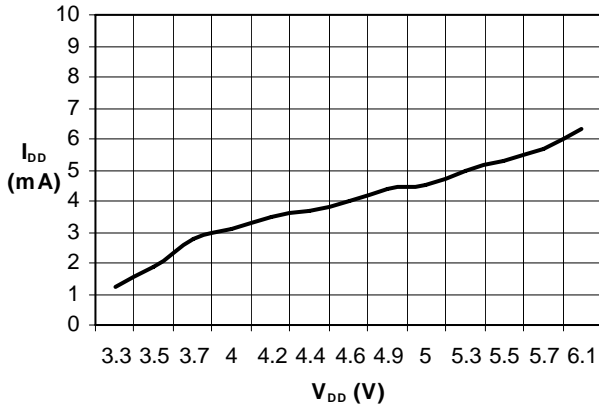

Figure 4: Supply Current vs Load Capacitor

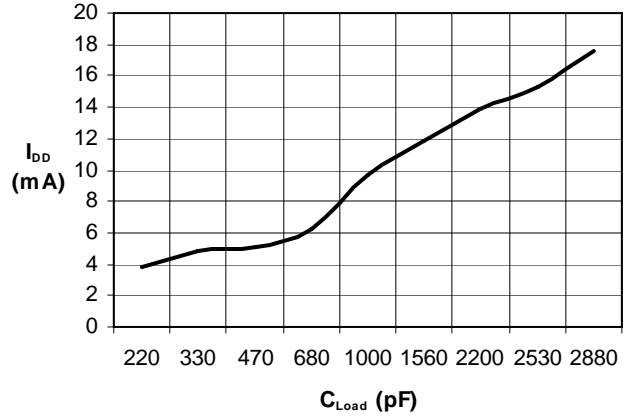

Figure 2: Output Rise Time vs Load Capacitor

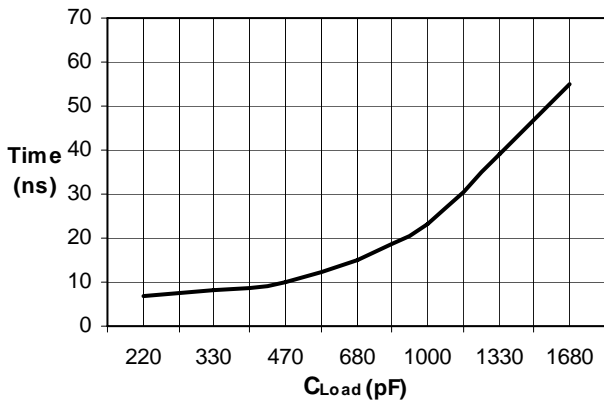

Figure 5: Supply Current vs Freq. @ No Load

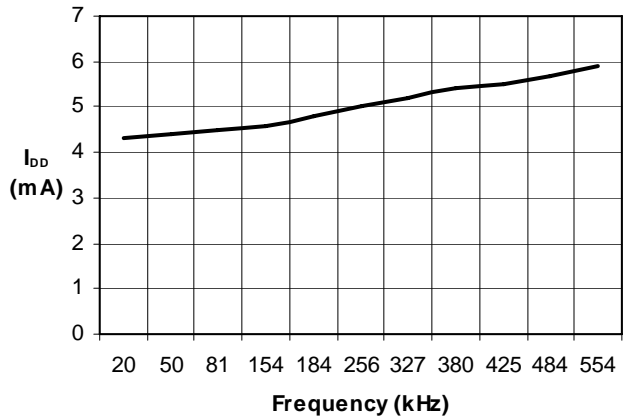

Figure 3: Output Fall Time vs Load Capacitor

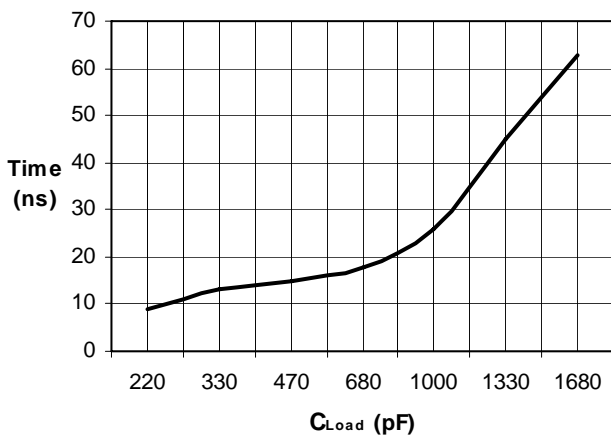
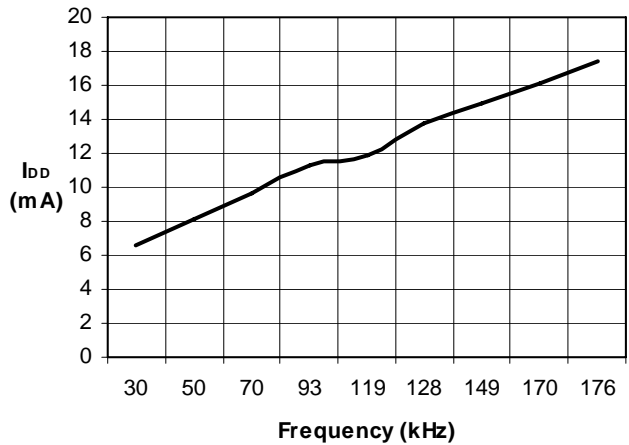

Figure 6: Supply Current vs Freq. @ Load=1nF



\*Fig. 2-4: Frequency = 85 kHz.



# SP6003

## Synchronous Rectifier Driver

### SOP- 8 PACKAGE OUTLINE

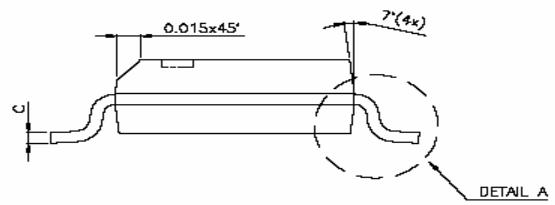
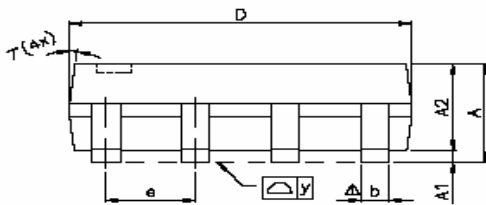
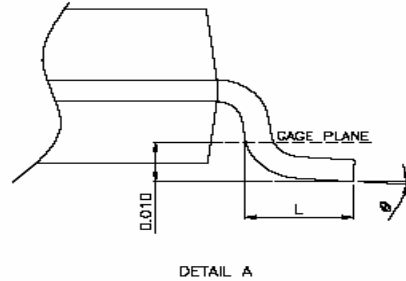
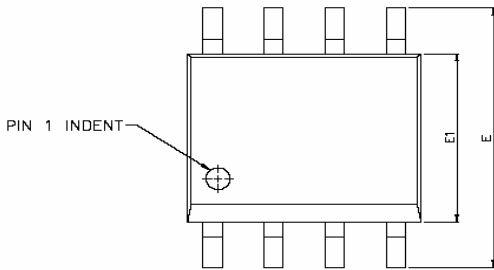

SYMBOLS	DIMENSIONS IN MILLIMETERS			DIMENSIONS IN INCHES		
	MIN	NOM	MAX	MIN	NOM	MAX
A	1.47	1.60	1.73	0.058	0.063	0.068
A1	0.10	—	0.25	0.004	—	0.010
A2	—	1.45	—	—	0.057	—
b	0.33	0.41	0.51	0.013	0.016	0.020
C	0.19	0.20	0.25	0.0075	0.008	0.0098
D	4.80	4.85	4.95	0.189	0.191	0.195
E	5.80	6.00	6.20	0.228	0.236	0.244
E1	3.80	3.90	4.00	0.150	0.154	0.157
e	—	1.27	—	—	0.050	—
L	0.38	0.71	1.27	0.015	0.028	0.050
$\Delta$ y	—	—	0.076	—	—	0.003
$\theta$	0°	—	8°	0°	—	8°



# SP6003

## Synchronous Rectifier Driver

---

Information provided is alleged to be exact and consistent. SYNC Power Corporation presumes no responsibility for the penalties of use of such information or for any violation of patents or other rights of third parties, which may result from its use. No license is granted by allegation or otherwise under any patent or patent rights of SYNC Power Corporation. Conditions mentioned in this publication are subject to change without notice. This publication surpasses and replaces all information previously supplied. SYNC Power Corporation products are not authorized for use as critical components in life support devices or systems without express written approval of SYNC Power Corporation.

©The SYNC Power logo is a registered trademark of SYNC Power Corporation  
©2004 SYNC Power Corporation – Printed in Taiwan – All Rights Reserved  
SYNC Power Corporation  
9F-5, No.3-2, Park Street  
NanKang District (NKSP), Taipei, Taiwan, 115, R.O.C  
Phone: 886-2-2655-8178  
Fax: 886-2-2655-8468  
<http://www.syncpower.com>