



# SP2526

## Low ESR Cap. Compatible Positive Voltage Regulators

### DESCRIPTION

The SP2526 family is a positive voltage linear regulators, low power consumption, high voltage, manufactured using CMOS technology. The SP2526 family provides large currents with a low dropout voltage. The SP2526 consists of current limiter circuit, driver transistor, precision reference voltage and error correction circuit.

The SP2526 family is compatible with low ESR capacitors. The current limiter's feedback circuit also operates as a short protect for the output current limiter. The SOT-23-3L / SOT-323 / SOT-353 packages are available for portable electronic equipment.

### FEATURES

- ◆ Maximum Output Current 250mA (3.3V type)
- ◆ Dropout Voltage 140mV @ 100mA (3.3V type)
- ◆ Maximum Operating Voltage 7.0V
- ◆ Output Voltage :  
1.5V ; 1.8V ; 2.5V ; 3.0V ; 3.1V ; 3.3V
- ◆ Highly Accurate  $\pm 2\%$
- ◆ Low Power Consumption 1.0 $\mu$ A (TYP.)
- ◆ Ultra Small Pb-Free Packages
- ◆ Low ESR capacitor ceramic compatible

### APPLICATIONS

- Battery Power Equipment
- Cellular Phone
- Digital Cameras
- Computer Disk Drivers
- Portable games
- Communication tools

### PIN CONFIGURATION

SOT-23-3L

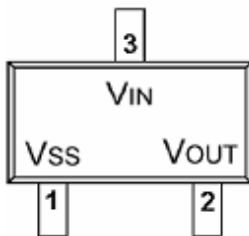

SOT-323 ( V<sub>OUT</sub> = 1.5 V )

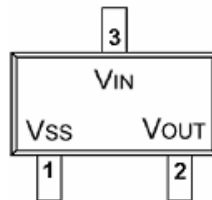

SOT-353

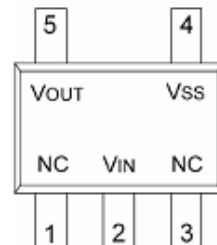

### PART MARKING

SOT-23-3L

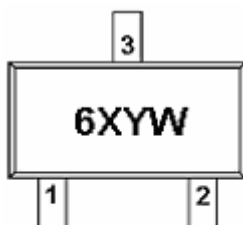

X : Voltage Code  
Y : Year Code  
W : Week Code

SOT-323 ( V<sub>OUT</sub> = 1.5 V )



X : Voltage Code  
Y : Year Code  
W : Week Code

SOT-353



X : Voltage Code  
Y : Year Code  
W : Week Code



# SP2526

## Low ESR Cap. Compatible Positive Voltage Regulators

### APPLICATION CIRCUIT

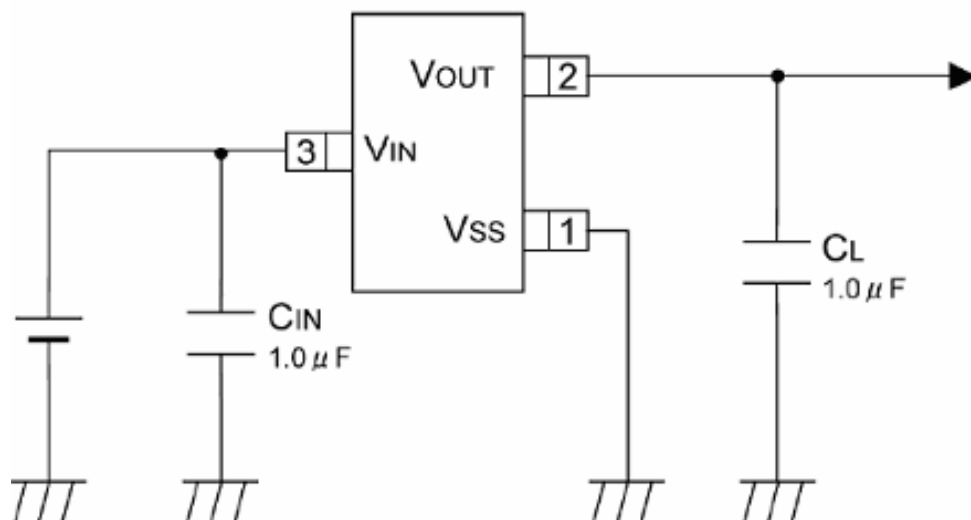

### PIN DESCRIPTION

SOT-23-3L	SOT-323	SOT-353	Symbol	Description
1	1	4	VSS	Ground
2	2	5	VOUT	Voltage Output
3	3	2	VIN	Voltage Input

### ORDERING INFORMATION ( X : Voltage Code ; Y : Year Code ; W : Week Code )

Part Number	Package	Part Marking
SP2526XS23RG	SOT-23-3L	6XYW
SP2526XS35RG	SOT-353	6XYW
SP2526AS32RG	SOT-323	6AYW

※ Week Code : A ~ Z ( 1 ~ 26 ) ; a ~ z ( 27 ~ 52 )

※ SP2526XS23RG : Tape Reel ; Pb – Free

※ SP2526XS35RG : Tape Reel ; Pb – Free

※ SP2526AS32RG : Tape Reel ; Pb – Free

### VOLTAGE CODE INFORMATION

Voltage Code (X)	Output Voltage (V)
A	1.5
D	1.8
K	2.5
P	3.0
Q	3.1
S	3.3



# SP2526

## Low ESR Cap. Compatible Positive Voltage Regulators

### BLOCK DIAGRAM

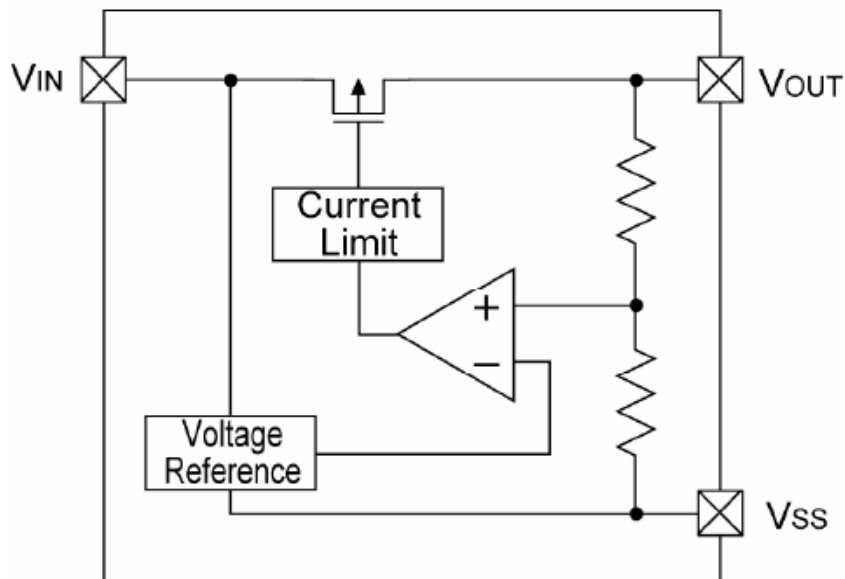

### TEST CIRCUIT

Circuit 1 :

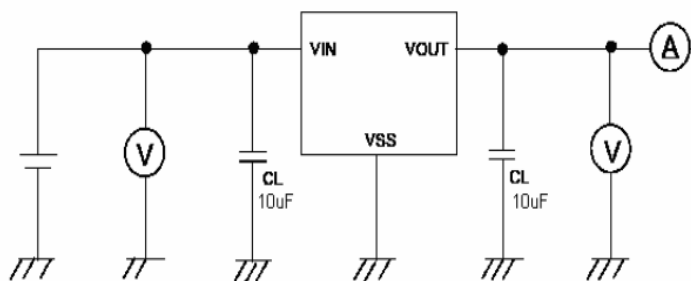

Circuit 2 :

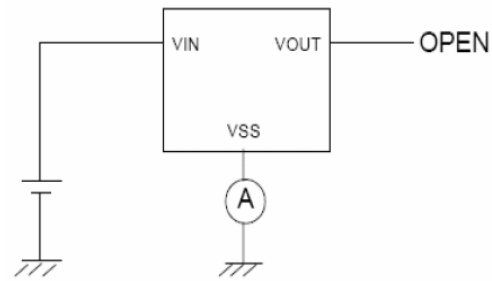

### ABSOLUTE MAXIMUM RATINGS

( $T_A=25^{\circ}\text{C}$  Unless otherwise specified)

Parameter	Symbol	Value	Unit
Input Voltage	$V_{IN}$	7	V
Output Current	$I_{OUT}$	500	mA
Output Voltage	$V_{OUT}$	$V_{SS}-0.3 \sim V_{IN}+0.3$	mV
Thermal Resistance	$\theta_{JA}$	SOT-23-3L	120
		SOT-323	105
		SOT-353	105
Power Dissipation	$P_D$	SOT-23-3L	1250
		SOT-323	330
		SOT-353	950
Operation Junction Temperature Range	$T_J$	-40 ~ +85	$^{\circ}\text{C}$
Storage Temperature Range	$T_{STG}$	-55 ~ +125	$^{\circ}\text{C}$



# SP2526

## Low ESR Cap. Compatible Positive Voltage Regulators

### ELECTRICAL CHARACTERISTICS

(TA=25°C , Unless otherwise specified)

Parameter	Symbol	Conditions	Min.	Typ.	Max.	Unit
Output Voltage	V <sub>OUT(E)</sub>	I <sub>OUT</sub> = 30mA	x 0.98	V <sub>OUT(T)</sub>	x 1.02	V
Maximum Output Current	I <sub>OUT</sub>	V <sub>IN</sub> =5V	<b>E-1</b>			mA
Load Regulation	ΔV <sub>OUT</sub>	V <sub>IN</sub> =V <sub>OUT</sub> +1.0 V 1mA ≤ I <sub>OUT</sub> ≤ 100mA			V <sub>OUT(T)</sub> x 1%	mV
Dropout Voltage	V <sub>dif 1</sub>	I <sub>OUT</sub> =30mA			<b>E-2</b>	mV
	V <sub>dif 2</sub>	I <sub>OUT</sub> =100mA			<b>E-3</b>	mV
Supply Current	I <sub>DD</sub>	V <sub>IN</sub> =5V		2.0	3.0	uA
Line Regulations	V <sub>OUT</sub> / (ΔV <sub>IN</sub> - V <sub>OUT</sub> )	V <sub>OUT(T)</sub> +0.5V ≤ V <sub>IN</sub> ≤ 5.5V I <sub>OUT</sub> = 30mA		0.15	0.30	%/V
Input Voltage	V <sub>IN</sub>		1.8		7	V
Ripple-Rejection	PSRR	V <sub>IN</sub> =V <sub>OUT</sub> +1.0V, f=1 kHz V <sub>rip</sub> =0.5V <sub>rms</sub> , I <sub>OUT</sub> =60 mA		40		dB
Output Voltage Temperature Characteristics	ΔV <sub>OUT</sub> / (ΔT <sub>opr</sub> - V <sub>OUT</sub> )	I <sub>OUT</sub> =30mA -40°C ≤ T <sub>opr</sub> ≤ 85°C		±100		ppm/°C
Short Current	I <sub>short</sub>	V <sub>IN</sub> =V <sub>OUT</sub> +1.5V, V <sub>OUT</sub> =V <sub>SS</sub>		<b>E-4</b>		mA

(NOTE 1) V<sub>OUT(T)</sub> = Specified Output Voltage

(NOTE 2) V<sub>OUT(E)</sub> = Effective Output Voltage (i.e. The output voltage when "V<sub>OUT(T)</sub>+1.0V" is provided at the V<sub>IN</sub> pin while maintaining a certain I<sub>OUT</sub> value.)

(NOTE 3) V<sub>dif</sub> = {V<sub>IN 1</sub> (NOTE5) + V<sub>OUT 1</sub> (NOTE4)}

(NOTE 4) V<sub>OUT 1</sub> = A voltage equal to 98% of the Output Voltage whenever an amply stabilized I<sub>OUT</sub> {V<sub>OUT(T)</sub> + 1.0V} is input.

(NOTE 5) V<sub>IN 1</sub> = The Input Voltage when V<sub>OUT 1</sub> appears as Input Voltage is gradually decreased.

(NOTE 6) Unless otherwise stated, V<sub>IN</sub> = V<sub>OUT(T)</sub>+1.0V

### ELECTRICAL CHARACTERISTICS LIST

(TA=25°C , Unless otherwise specified)

V <sub>OUT</sub> (TA=25°C)	V <sub>OUT</sub> (2%)		E-1	E-2		E-3		E-4
			I <sub>OUT</sub>	V <sub>dif 1</sub>		V <sub>dif 1</sub>		I <sub>short</sub>
	Min	Max	Min	Typ	Max	Typ	Max	Typ
1.5	1.470	1.530	200	350	500	750	850	155
1.8	1.764	1.836	250	90	150	250	350	130
2.5	2.450	2.550	250	65	120	200	300	115
3.0	2.940	3.060	250	40	100	150	200	80
3.1	3.038	3.162	250	40	100	150	200	80
3.3	3.234	3.366	250	35	100	140	200	80



# SP2526

## Low ESR Cap. Compatible Positive Voltage Regulators

### PERFORMANCE CHARACTERISTICS ( Voltage Code = Z ; 3.0V )

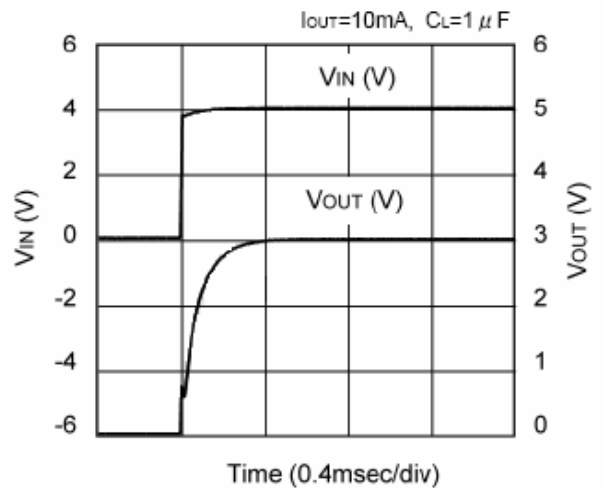
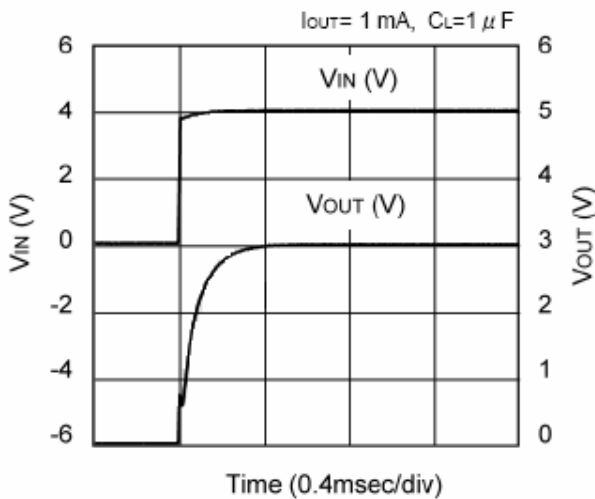
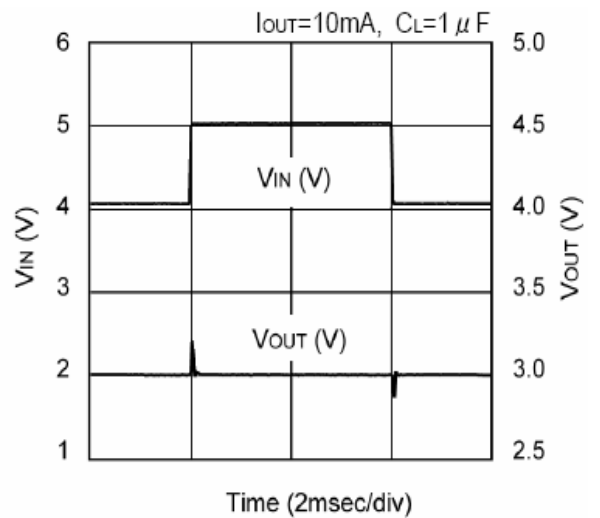
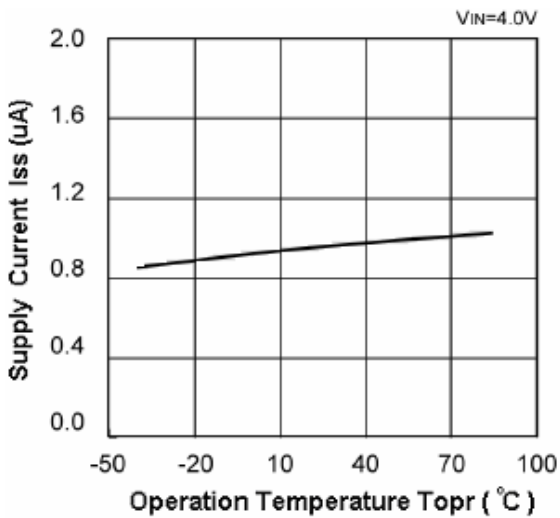
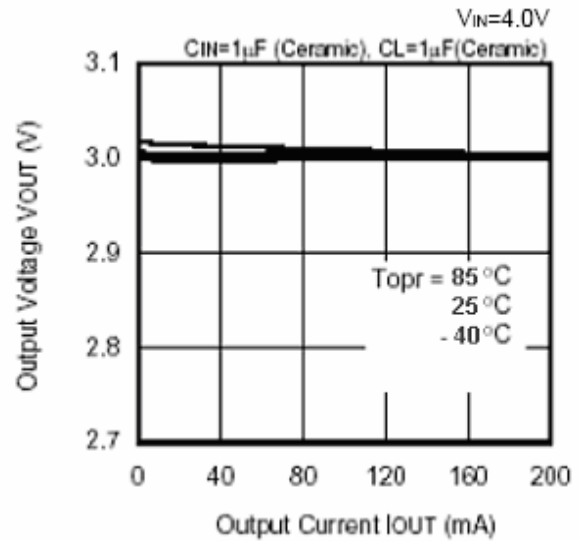
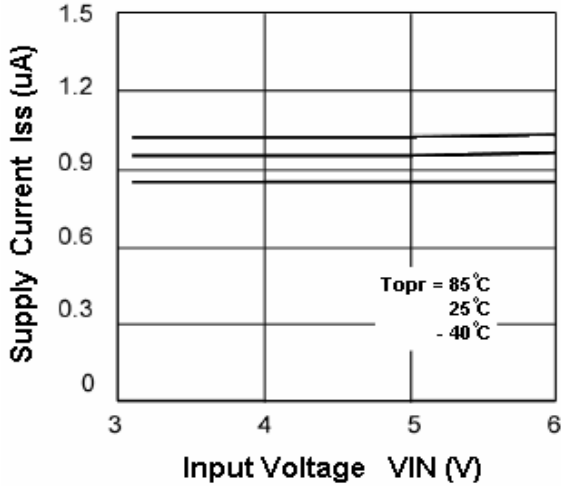



# SP2526

## Low ESR Cap. Compatible Positive Voltage Regulators

### PERFORMANCE CHARACTERISTICS ( Voltage Code = Z ; 3.0V )

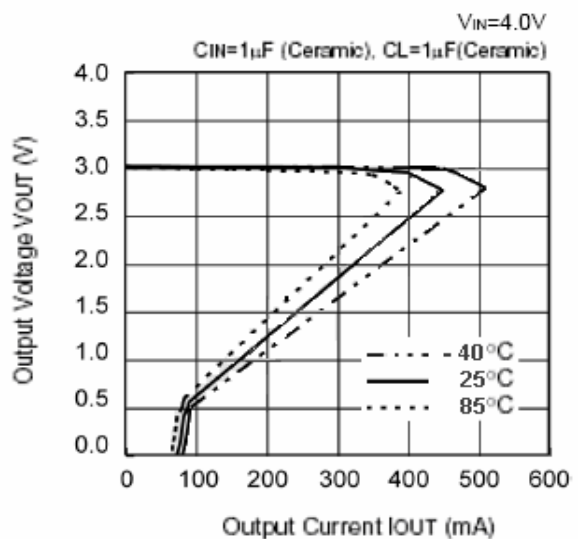
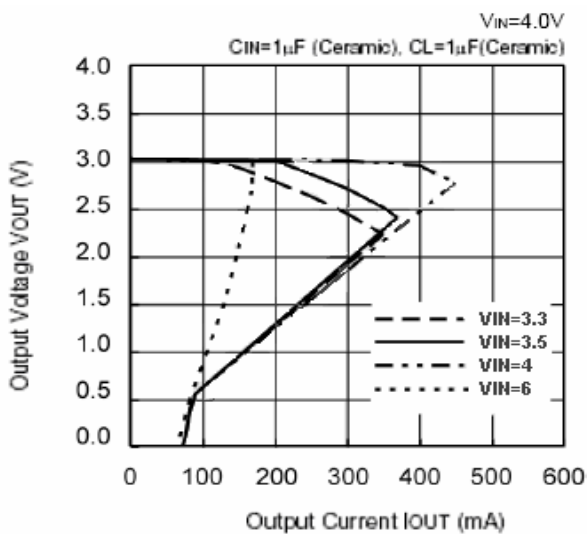
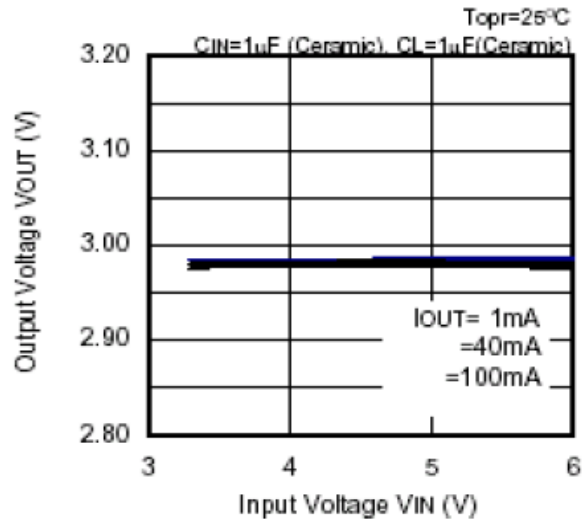
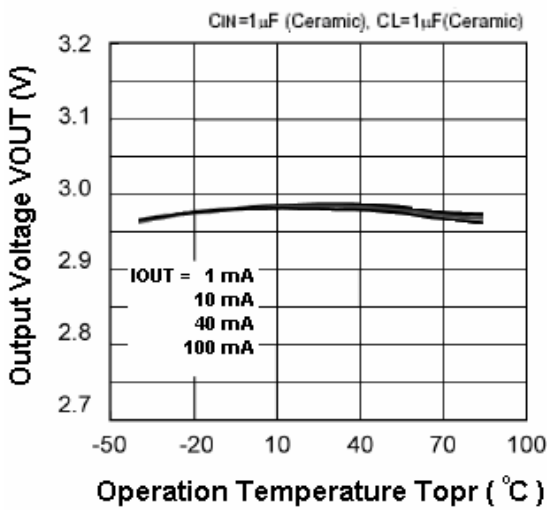
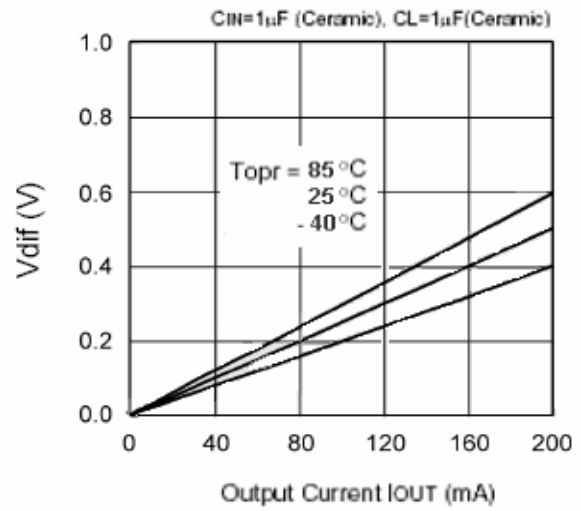
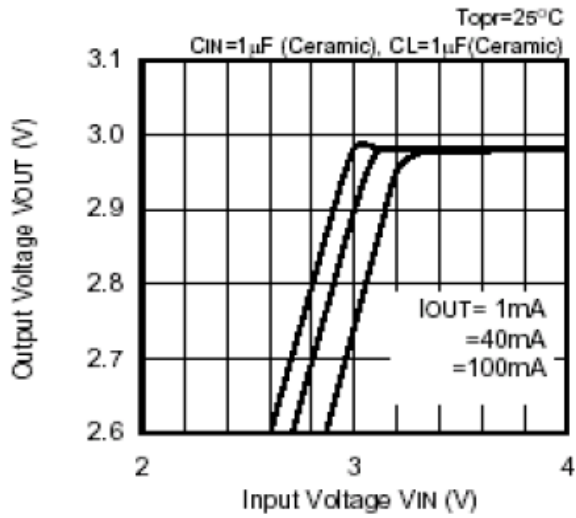



# SP2526

## Low ESR Cap. Compatible Positive Voltage Regulators

### SOT-23-3L PACKAGE OUTLINE

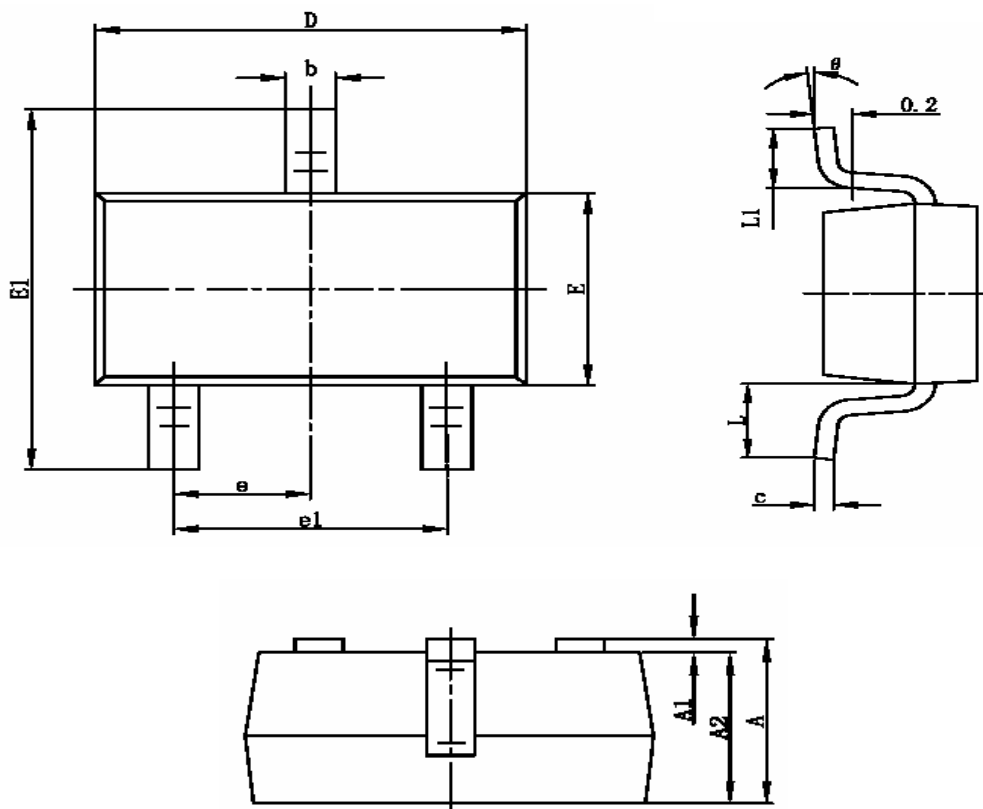

Symbol	Dimensions In Millimeters		Dimensions In Inches	
	Min	Max	Min	Max
A	1.050	1.250	0.041	0.049
A1	0.000	0.100	0.000	0.004
A2	1.050	1.150	0.041	0.045
b	0.300	0.400	0.012	0.016
c	0.100	0.200	0.004	0.008
D	2.820	3.020	0.111	0.119
E	1.500	1.700	0.059	0.067
E1	2.650	2.950	0.104	0.116
e	0.950TYP		0.037TYP	
e1	1.800	2.000	0.071	0.079
L	0.700REF		0.028REF	
L1	0.300	0.600	0.012	0.024
θ	0°	8°	0°	8°



# SP2526

## Low ESR Cap. Compatible Positive Voltage Regulators

### SOT-323 PACKAGE OUTLINE

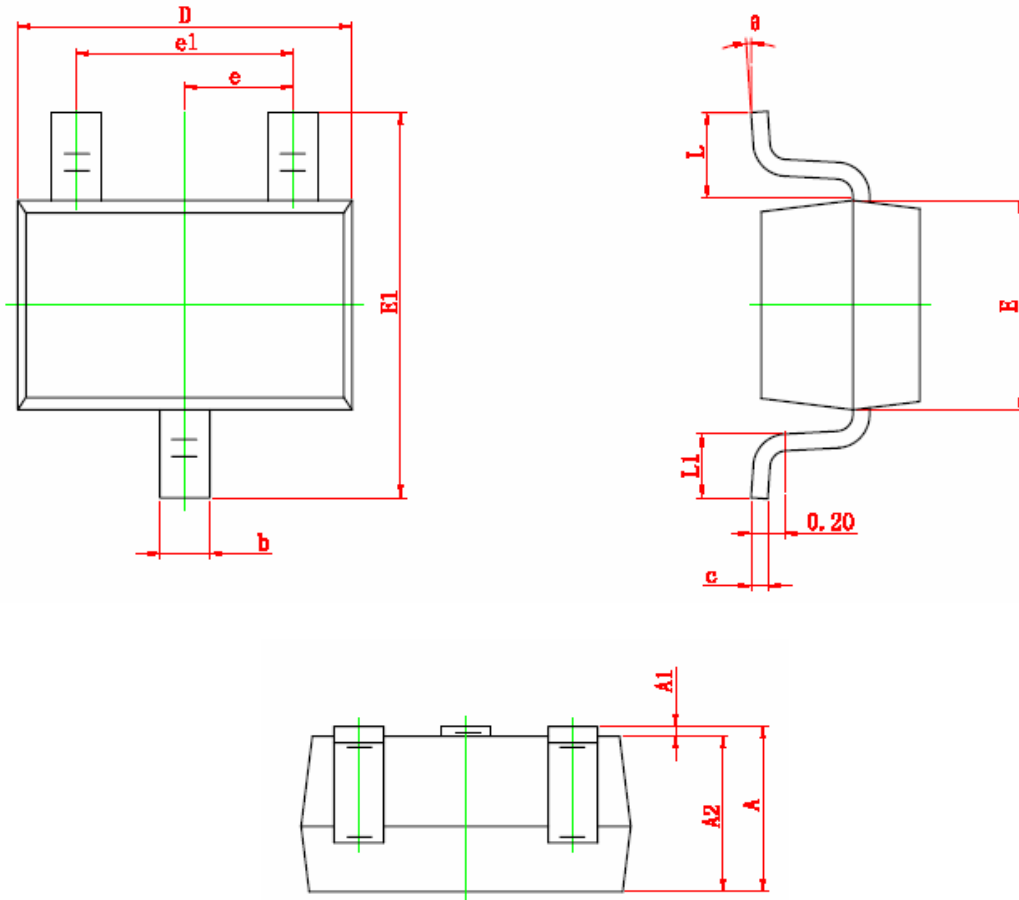

Symbol	Dimensions In Millimeters		Dimensions In Inches	
	Min	Max	Min	Max
A	0.900	1.100	0.035	0.043
A1	0.000	0.100	0.000	0.004
A2	0.900	1.000	0.035	0.039
b	0.200	0.400	0.008	0.016
c	0.080	0.150	0.003	0.006
D	2.000	2.200	0.079	0.087
E	1.150	1.350	0.045	0.053
E1	2.150	2.450	0.085	0.096
e	0.650 TYP		0.026 TYP	
e1	1.200	1.400	0.047	0.055
L	0.525 REF		0.021 REF	
L1	0.260	0.460	0.010	0.018
θ	0°	8°	0°	8°





# SP2526

## Low ESR Cap. Compatible Positive Voltage Regulators

### SOT-353 PACKAGE OUTLINE

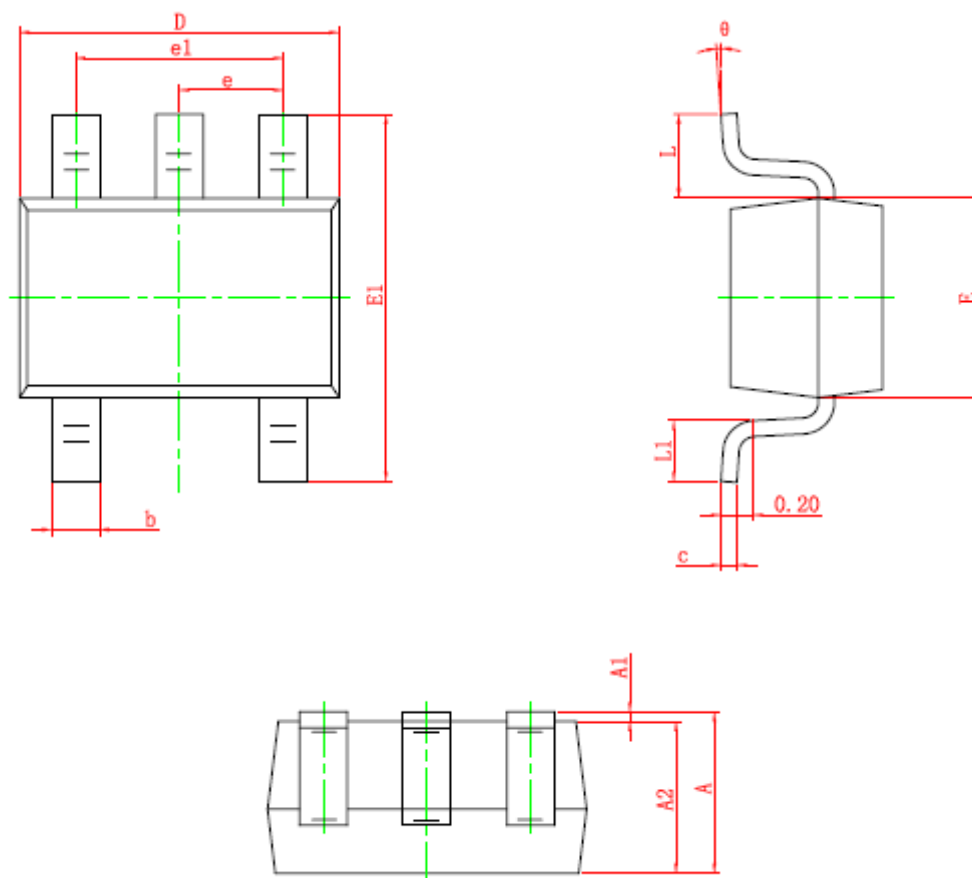

Symbol	Dimensions In Millimeters		Dimensions In Inches	
	Min	Max	Min	Max
A	0.900	1.100	0.035	0.043
A1	0.000	0.100	0.000	0.004
A2	0.900	1.000	0.035	0.039
b	0.150	0.350	0.006	0.014
c	0.080	0.150	0.003	0.006
D	2.000	2.200	0.079	0.087
E	1.150	1.350	0.045	0.053
E1	2.150	2.450	0.085	0.096
e	0.650 TYP		0.026 TYP	
e1	1.200	1.400	0.047	0.055
L	0.525 REF		0.021 REF	
L1	0.260	0.460	0.010	0.018
θ	0°	8°	0°	8°



# SP2526

## Low ESR Cap. Compatible Positive Voltage Regulators

---

Information provided is alleged to be exact and consistent. SYNC Power Corporation presumes no responsibility for the penalties of use of such information or for any violation of patents or other rights of third parties which may result from its use. No license is granted by allegation or otherwise under any patent or patent rights of SYNC Power Corporation. Conditions mentioned in this publication are subject to change without notice. This publication surpasses and replaces all information previously supplied. SYNC Power Corporation products are not authorized for use as critical components in life support devices or systems without express written approval of SYNC Power Corporation.

©The SYNC Power logo is a registered trademark of SYNC Power Corporation

©2004 SYNC Power Corporation – Printed in Taiwan – All Rights Reserved

SYNC Power Corporation

9F-5, No.3-2, Park Street

NanKang District (NKSP), Taipei, Taiwan 115

Phone: 886-2-2655-8178

Fax: 886-2-2655-8468

©<http://www.syncpower.com>